

This is an electronic reprint of the original article. This reprint may differ from the original in pagination and typographic detail.

Environmentally friendly steam generation using VHTHPs at a pharmaceutical research facility

Tveit, Tor- Martin; Johansson, Martin; Zevenhoven, Cornelis A P

Published in:
The 13th International Energy Agency Heat Pump Conference

Published: 01/01/2021

Document Version
Publisher's PDF, also known as Version of record

Document License
Unknown

[Link to publication](#)

Please cite the original version:
Tveit, T. M., Johansson, M., & Zevenhoven, C. A. P. (2021). Environmentally friendly steam generation using VHTHPs at a pharmaceutical research facility. In *The 13th International Energy Agency Heat Pump Conference: Mission for the Green World* (13 ed., pp. 91-98). [004] (Proceedings IEA Heat pump conference). Technology Collaboration Programme on Heat Pumping Technologies by International Energy Agency. <https://urn.fi/URN:NBN:fi-fe202201148554>

General rights

Copyright and moral rights for the publications made accessible in the public portal are retained by the authors and/or other copyright owners and it is a condition of accessing publications that users recognise and abide by the legal requirements associated with these rights.

Take down policy

If you believe that this document breaches copyright please contact us providing details, and we will remove access to the work immediately and investigate your claim.



13th IEA Heat Pump Conference
April 26-29, 2021 Jeju, Korea

Environmentally friendly steam generation using VHTHPs at a pharmaceutical research facility

Tor-Martin Tveit ^{*a,c}, Martin N. Johansson ^b, Ron Zevenhoven ^{ch}

^a Olvondo Technology AS, Langgata 21 A, NO-3080 Holmestrand, Norway

^b AstraZeneca R&D, Pepparedsleden 1, SE-431 83 Mölndal, Sweden

^c Åbo Akademi University, Biskopsgatan 8, FI-20500 Åbo, Finland

Abstract

This paper presents a case study where steam at 1 MPa and 183°C (~140 psi/360°F) is produced using very high temperature heat pumps (VHTHPs) at a pharmaceutical research facility. Steam as an energy carrier has many benefits, and steam systems are also flexible when it comes to the primary source; steam can be generated using heat from combustion of fossil- or renewable fuels, nuclear reactors or directly from electricity. Generating steam using a heat pump can reduce greenhouse gas emissions. At full-scale operation the potential reduction in CO₂-emissions is more than 80%. The heat source for the heat pumps is mainly waste heat from cooling compressors at around 40°C (~100°F). The refrigerant is a natural refrigerant R-704 (Helium). Helium has both global warming potential (GWP) and ozone depletion potential (ODP) equal to zero and the toxicity and flammability classification of Helium is "A1". The working medium stays a gas throughout the cycle, which makes the heat pump process very suitable for use as VHTHPs while the heat pumps are highly adaptive to any changes in the sink or source temperatures.

© HPC2020.

Selection and/or peer-review under responsibility of the organizers of the 13th IEA Heat Pump Conference 2020.

Keywords: VHTHP; steam generation; helium; waste heat; sustainable working medium

1. Introduction

Health is central to a functioning society and connects us all. The pharma industry is a global industry given the possibility to provide health solutions valid to patients all around the globe. Being global in the health sector, one has to address the global issues affecting people's health. AstraZeneca recognises the strong connection between a healthy planet and healthy people and works with environmental protection. AstraZeneca's approach doing this is to follow the science, using science-based targets. The greenhouse gas emission targets are in line with limiting global warming to 1.5 degrees. A big part of lowering CO₂ emissions is to move from the use of fossil fuel to renewable energy. In the pharma industry steam is commonly used to provide the utility needed. Due to the temperature needed, steam is usually produced with fossil fuel, on site, and accounts for a large part of the energy usage at a pharma plant.

AstraZeneca Gothenburg have historically used fossil fuel for steam production with a switch from oil to natural gas in 1997. In 2018 a new switch took place, this time from fossil natural gas to biogas, to produce steam with a low carbon fuel. A technical part of the upgrade was to pursuing steam production using high lift heat pumps - a more efficient, more robust, less expensive and if possible, even more sustainable solution.

To do this, the site has installed 3 high lift heat pumps. Each with a capacity of 500 kW_{th} at 10 bars steam system pressure and rejected heat from the chillers for the air condition as a heat source. Another one is schedule for 2020 with a capacity of 750 kW_{th}.

* Corresponding author. Tel.: +358 405739890

E-mail address: tor-martin.tveit@olvondotech.no.

2. State-of-the-art of high and very high temperature heat pumps

There is no common acceptable definition of high temperature heat pumps (HTHP) or very high temperature heat pumps (VHTHP). In their paper Arpagaus et al. [1] present some of the previous definitions and uses the definition as shown in the figure below.

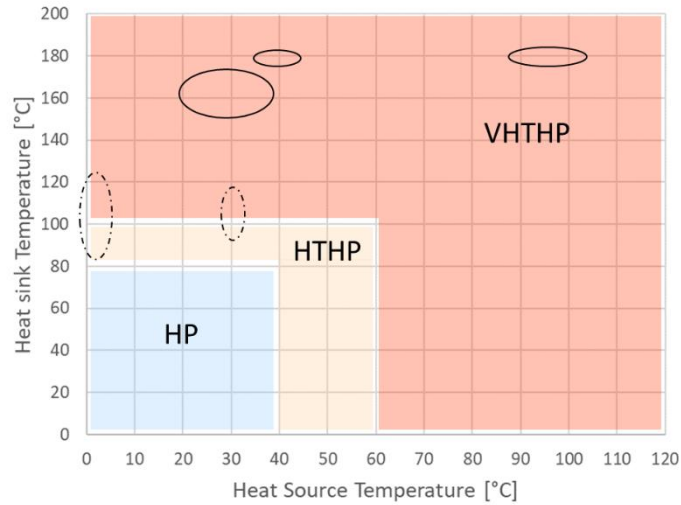

Figure 1. Classification of heat pumps according to the sink and source temperatures. The figure is adapted from Arpagaus et al. [1]. The temperature range is extended to accommodate the possible temperatures for the HighLift heat pump. The solid line ellipses represent the temperatures for current HighLift installations, where the dotted ellipses represent earlier prototypes that are no longer in operation.

Arpagaus et al. identified more than thirteen manufacturers worldwide working on high temperature heat pumps in 2018. The technology, i.e. heat pump cycle and refrigerants, used in the heat pumps is diverse, though most use a single-stage vapour compressor cycle.

There is a lot of research and development in the field of high temperature heat pumps. For example, in the 12th IEA Heat Pump Conference (2017, Rotterdam), more than 40% of the presentations in the “industry” sessions discussed aspects of high temperature heat pumps. This indicates that there are likely more manufacturers with more mature high temperature heat pumps in the market today.

3. Environmental impact of heat pumps: energy use sustainability and environmental impact

In today’s world, the increased availability of electricity from renewable sources may on one hand be intermittent but on the other hand is more predictable than the pricing levels for natural gas. In principle, HPs use a cheap renewable source for both input heat and electricity. System purchases are nonetheless often motivated by an attractive coefficient of performance (COP). Industry is increasingly implementing HP technology that circumvents the production of CO₂ when producing heat, although reaching sufficiently high temperatures may be challenging. A Stirling engine-based heat pump is one approach towards higher output temperatures. A challenge related to the goals of increasing output as well as efficiency, viz. the HighLift concept and its development, is that it conflicts with the thermodynamics that describes heat engines if the goals are simplified to having

- a higher temperature at the hot (water) side of the engine and a larger flow of heat carrier (helium) which can be achieved by raising the pressure of operation, and
- a higher coefficient of performance (COP_h), defined as heat output Q_{out} obtained per input of work (here electricity) W, with energy balance Q_{out} = W + Q_{in}, and COP_h = Q_{out}/W.

For an ideal, reversible heat engine the highest theoretical (Carnot) efficiency is defined as

$$COP_{Carnot} = \frac{Q_{out,reversible}}{W} = \frac{Q_{out,reversible}}{Q_{out,reversible} - Q_{in,reversible}} = \frac{T_H}{T_H - T_L} = \frac{1}{1 - \frac{T_L}{T_H}} \quad (1)$$

with the higher and lower temperatures of operation T_H and T_L, in K. This shows that raising the output heat temperature T_H with given T_L will inevitably result in a lower efficiency, or COP_h. For an engine that heats water from T_L ~ 300 K to T_H ~ 450 K the theoretical maximum COP equals COP_{Carnot} = 3. Current operation of the HighLift Stirling HP (500 kW per engine, heating water from 30°C to 180°C) gives a COP_h of 1.4 –

1.5: the goal is to raise that to COP_h 1.8 – 1.9 while heating water from 30°C to 200°C at an output of 750 kW. A more general approach of efficiency improvement of real systems involves suppressing irreversibilities that arise from

- friction between moving parts
- heat transfer across large temperature differences
- viscous flow friction in fluid flow lines and flow inlet/outlet section
- compression and expansion losses
- material losses as a result of leakage

Reducing friction between moving parts can be achieved by proper design of rigid and flexible parts, and lubricant oils. Heat transfer is impossible without a temperature difference and a trade-off must be made (based on costs) between a large area for heat exchange operating with small temperature difference or vice versa: the first option gives higher losses. Viscous flow losses can be directly related to pressure drop and obviously a leakage of material at elevated pressure and temperature implies an obvious loss of energy. The first three listed will result in a production of entropy at a rate \dot{S}_{gen} which can be used to quantify losses as $\dot{W}_{losses} = T^o \cdot \dot{S}_{gen}$ (J/s). Here, T^o is the temperature of the surroundings, in K (here assumed = 288 K).

These losses imply that a larger work (electricity) input is needed for a given output heat target Q_{out} for a real system:

$$COP_h = \frac{\dot{Q}_{out}}{\dot{W}_{reversible} + \dot{W}_{losses}} = \frac{\dot{Q}_{in} + \dot{W}_{reversible} + \dot{W}_{internal\ losses} \left(1 - \frac{T^o}{T}\right)}{\dot{W}_{reversible} + \dot{W}_{losses}} < \frac{\dot{Q}_{out, reversible}}{\dot{W}_{reversible}} \quad (2)$$

with the (beneficial) complication that viscous friction results in heat that is taken up by a flow that is to be heated, which is not at all a full loss for a Stirling engine heat pump. Therefore, in (2) the internal losses that imply waste heat generation inside the Stirling engine are distinguished from external losses that cross the Stirling engine system boundary. For heat Q at temperature T produced from work W , the losses equate to $W \cdot (T^o/T)$. It is clear that a larger electricity input is needed in order to cover for losses. See also Bejan (1997) [2] or Szargut et al. (1989) [3].

With an electrical-to-mechanical energy conversion efficiency $\eta_{elec} = 95\%$ and heat losses \dot{Q}_{losses} to the surroundings found to be of the order of 20-30 kW, i.e. 5% of 500 kW for current operation, equation (2) can be reworked to

$$COP_h = \frac{\dot{Q}_{out}}{\dot{W}_{in}} = \frac{\dot{Q}_{in} - \dot{Q}_{losses} + \dot{W}_{in} - \dot{W}_{losses} + \dot{W}_{losses\ giving\ heat}}{P_{elec} \cdot \eta_{elec}} < \frac{\dot{Q}_{out, reversible}}{\dot{W}_{reversible}} \quad (3)$$

correcting for input energy not contributing to raising the temperature of the water. Currently $P_{elec} \sim 315$ kW. Furthermore, heat transfer in the heat exchangers result in entropy production $\dot{S}_{gen} = \dot{Q} \cdot \frac{T_{hot} - T_{cold}}{T_{hot} \cdot T_{cold}}$ (with temperatures in K) giving losses $\dot{W}_{losses} = T^o \cdot \dot{S}_{gen}$, while pressure drop losses Δp (Pa) for (Helium) volume flow \dot{V} (m^3/s) give additional (viscous friction) losses $\dot{W}_{losses} = \Delta p \cdot \dot{V}$. Following the above, a fraction $(1 - T^o/T)$ of the viscous friction losses will add to the useful heat output of the system.

Thus, (3) can be rewritten to give:

$$COP_h = \frac{\dot{Q}_{in} - \dot{Q}_{losses} + \dot{W}_{in} - \dot{W}_{losses} + \sum \Delta p \cdot \dot{V} \cdot \left(1 - \frac{T^o}{T}\right)}{P_{elec} \cdot \eta_{elec}} < \frac{\dot{Q}_{out, reversible}}{\dot{W}_{reversible}} \quad (4)$$

The assessment for the heat exchange applies to the regenerator as well: apart from viscous friction losses the heat transfer involves losses that can be estimated for the cycling heat transfer to/from the helium medium from/to the regenerator material matrix. For the heat transfer, with heat transfer \dot{Q} to/from the helium with a temperature difference ΔT_{He} across the regenerator (here estimated \approx the average value for average He temperature in the two respective heat exchangers – see also [4]) the entropy production can be estimated using the expression given above with an estimated cycle-average temperature difference $T_{hot} - T_{cold} \sim 15$ K.

Using Ansys Fluent (v. 19.2) simulations for operation with pressure average 50 bar, amplitude 13 bar, frequency $10\ s^{-1}$ it was found that 500 kW heat output operation will give $\dot{W}_{losses} = 30 - 35$ kW for the two heat exchangers (being a bit higher for the low temperature heat exchanger than for the high temperature one). On top of this ~ 15 kW viscous flow losses occur inside the heat exchanger tubes. Pressure drop losses are much larger for the regenerator and inlet/outlet manifolds for that, giving ~ 40 kW viscous friction losses, while losses due to entropy generation in the regenerator add up to ~ 25 kW, with (cycle averaged) $T_{hot} - T_{cold} \approx 15$ K. (Pressure drop losses are not considered for the side of the water that is heated as the pumping of this

is outside the Stirling engine system boundary.) Examples of calculated results are given in Figure 2, showing velocity intensity and temperature profiles.

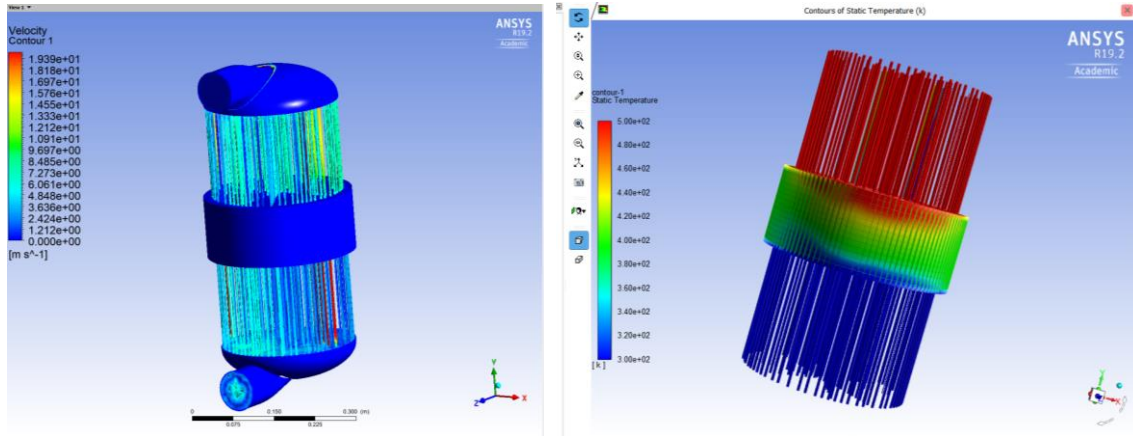

Figure 2. CFD simulated results for (cycle averaged) velocity (left) and temperature (right) for 500 kW heat output operation

A further source of losses are those related to real compression and expansion vs. ideal processes: for He the cycling expansion/compression from 37 to 63 bar gives losses of ~ 100 kW (the expansion stage giving somewhat larger values than the compression) – see [3, p119]. Fortunately these largely (~ 60%) imply generation of heat that stays inside the system (similar to the viscous friction losses), reducing the system losses to ~ 40 kW for this.

Combining all this gives with current operation with 300 kW effective power input that 45-50 kW of this is lost via entropy losses in the heat exchangers, while 55- 65 kW is lost in the regenerator plus ~ 40 kW compression/expansion losses. These add up to ~ 45% of the effective electricity input which, using the expressions for COP_h with heat input \dot{Q}_{in} being of the order of 300 kW explains the value $COP_h = 1.4 - 1.5$. For the heat exchangers, a different design that gives small temperature gradients would be beneficial while for the regenerator the reduction of viscous flow losses is most beneficial. Indeed, such improvements are currently being implemented to the HighLift Stirling engines.

An issue that primarily relates to costs of operation are losses of helium. These are modest yet non-zero but won't give contribution to the enhanced greenhouse effect or ozone layer depleting as values for global warming potential (GWP) and ozone depletion potential are = 0.

4. The HighLift heat pump

The HighLift heat pump process is based on the Stirling cycle. For a more detailed description of the mechanical implementation see the previous work by the authors [5a]. Descriptions of other applications can be found in the papers in previous proceedings [6a, 7a]. Modern Stirling engine development starts with the work done by Philips Electronics BV in the Netherlands in the 1940s. See for instance the book by Finkelstein and Organ [8] for a historical review of the modern Stirling engine. The ideal Stirling cycle is a thermodynamic process that consists of four reversible process in series. A description of the ideal Stirling cycle is available in most introductions to technical thermodynamics, for instance in the book by Moran and Shapiro [9]. Compared to compression and absorption heat pumps, the working medium in a Stirling process is a gas throughout the process. This implies that the process is independent of the evaporation and condensation temperatures of the working medium. A common question from persons not familiar with the Stirling process is related to the choice of working medium. Even though the full story is more complicated, the efficiency of the choice of working medium can easily be seen from the equation below describing the reversible work of an ideal Stirling cycle by an ideal gas.

$$W = -m \cdot R \cdot (T_h - T_c) \cdot \ln \left(\frac{V_1}{V_2} \right) \quad (5)$$

where m is the mass of the working medium, R is the specific gas constant of the working medium, V is the volume, and T is the temperature. Subscripts "1" and "2" refer to initial and final states. As can be seen from the equation, the higher the value of the specific gas constant, the higher the work output from the cycle.

Noting that the specific gas constant for hydrogen, helium and air are approximately 4000, 2100 and 300 J/kgK respectively, it is easily understood why hydrogen and helium are preferred working media to air or nitrogen. The same argument is also valid for the reverse (heat pump) Stirling cycle.

The configuration of the heat pump is a double-acting alpha Stirling engine of the “Franchot” type. “Double-acting” means that the working medium is acting on both sides of the pistons. The Franchot type means in contrast to a “Rinia” or “Siemens” type configuration, one of the cylinders is always containing cold gas and one of the cylinders is hot gas.

5. The heat pump installation at AstraZeneca

The current HighLift heat pump installation at the R&D facility at AstraZeneca in Gothenburg, Sweden, consists of three heat pumps. These heat pumps are designed to deliver 500 kW of steam at full load, and the main motor is a 315 kW nominal power eight poles asynchronous motor. Below, two of the heat pumps in the heat pump room are shown.



Figure 3. Two of the three heat pumps currently installed at AstraZeneca’s R&D facility in Gothenburg, Sweden. Heat is transferred to the heat pump from the heat recovery circuit and steam is delivered from the heat pumps’ steam generators to the steam distribution system. The third heat pump is installed on the opposite side of the room.

Main components of the installations in addition to the heat pumps are the cold circuits, the hot circuits and the steam generators. The cold circuits are closed water circuits that transfer heat from the heat recovery system at the site to the heat pumps. The hot circuits are closed, pressurised water circuits that transfer heat from the heat pump to the steam generators. The steam generators are shell and plate heat exchangers that get feed water from the site’s feed water tanks and generate steam by cooling the hot circuit from the heat pump. Steam thus generated is supplied directly to the steam distribution system at the site. The figure below (Fig 4) shows a simplified P&ID of the installation.

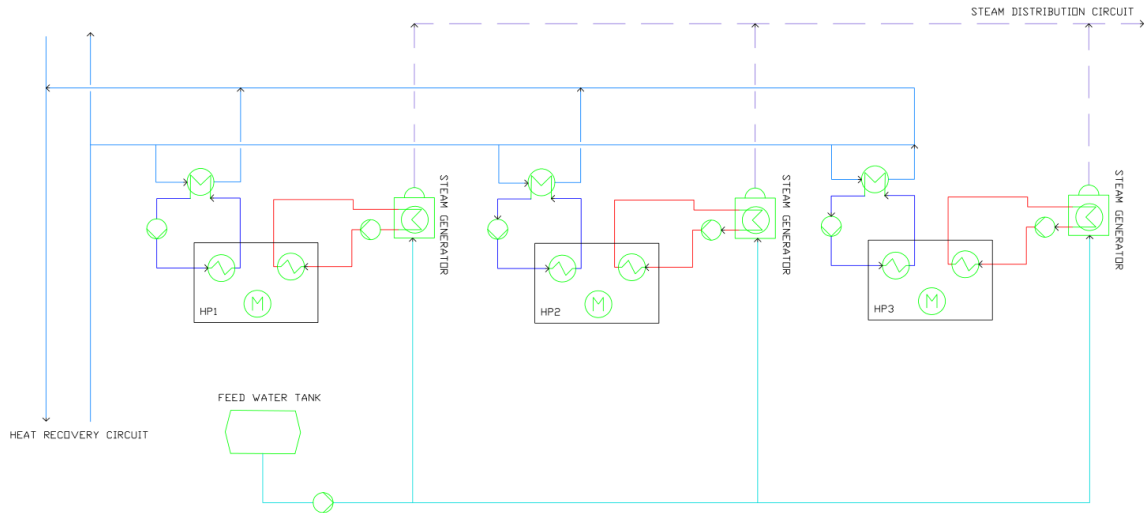

Figure 4. Simplified P&ID for the installation of the three heat pumps at the R&D facility. The cold heat source is a heat recovery circuit that is transferred indirectly to the heat pumps. The heat pump uses this heat to heat a hot circuit that circulates over a steam generator. The steam generator uses this heat to generate steam that is fed to the steam distribution circuit of the plant.

At the time of writing this, the heat pumps have been running for between 5000 and 6800 hours: pump #1 has a running time of 6800 hours, heat pump #2 5000 hours and heat pump #3 6500 hours respectively. The load has been varying, but the temperatures have remained quite constant. In order to present the performance of the heat pump, four cases have been selected from a two months period for heat pump #1. These are selected to have different load. Data for the cases is for a 30 hours period with 1-hour average values. The original data was sampled in 1s intervals except for the temperatures which were sampled in 10s intervals. In the following graphs the values are either based on average for all 30 hours or presented in form of intervals (box and whisker plots). The following figures (Fig. 5) show the average load for each period and the delivered heat as a function of the load for one heat pump.

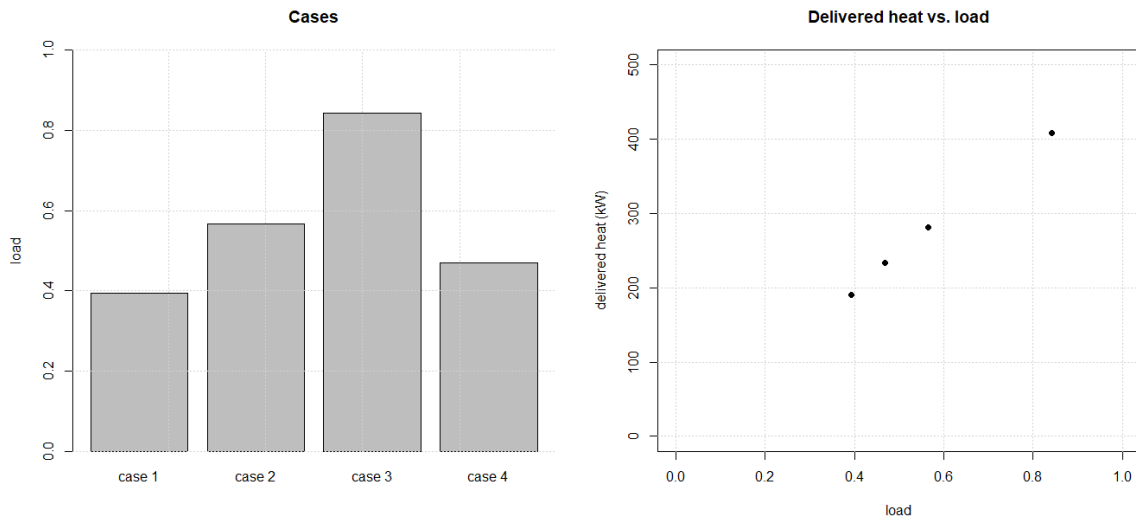

Figure 5. The load for the 4 cases for heat pump #1, where "1" equals full load. The loads and heat duty are average values for each of the cases.

The average temperatures of the external circuits are 183°C (363°F) and 27°C (75°F) on the hot and cold side respectively. The hot and cold side temperatures are presented in the two figures (Fig. 6 and Fig. 7) below.

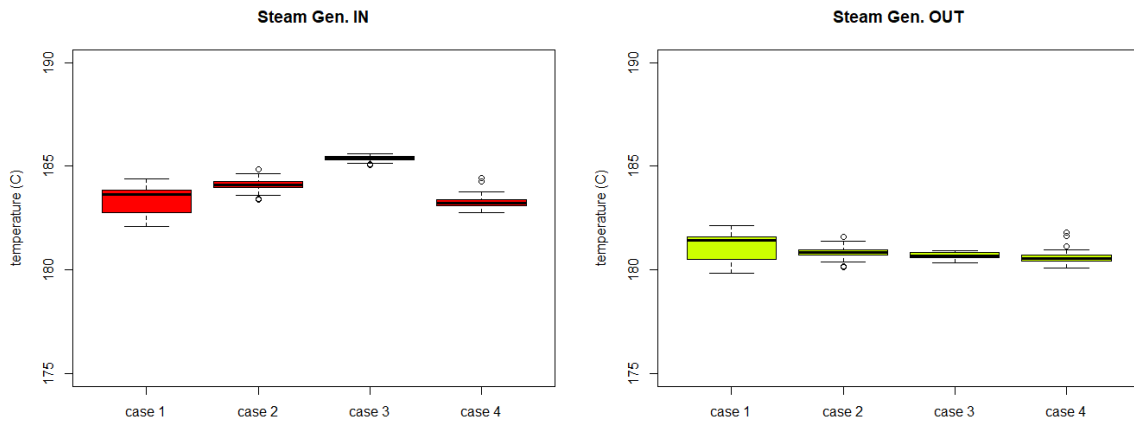

Figure 6. The temperatures of the hot circuit used to transfer heat from the heat pump to the steam generator. The hot water from the heat pump (steam gen. IN) enters the steam generator and heats the feedwater. The colder water is then returned to the heat pump.

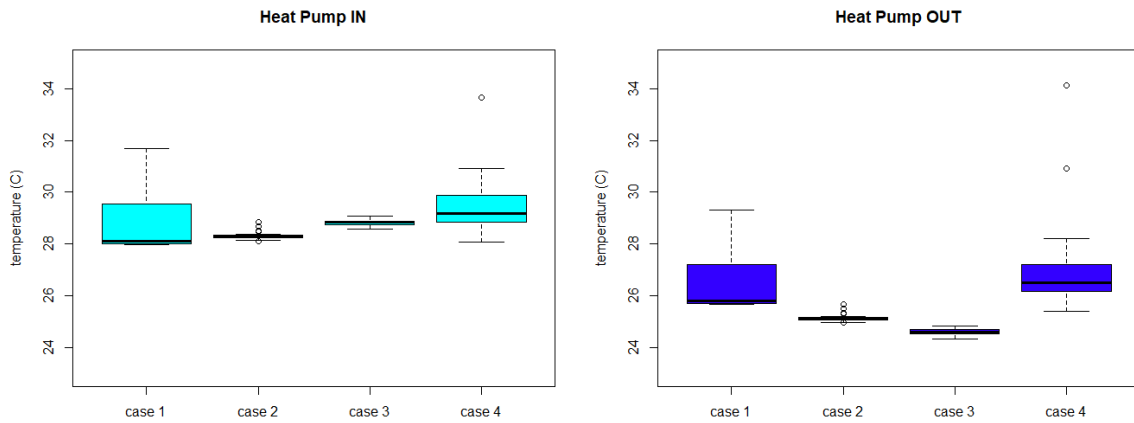

Figure 7. The heat is transferred from the heat recovery circuit to the heat pump via a closed circuit. The water enters the heat pump and is cooled down before returning to the heat exchanger between the closed circuit and the heat recovery circuit.

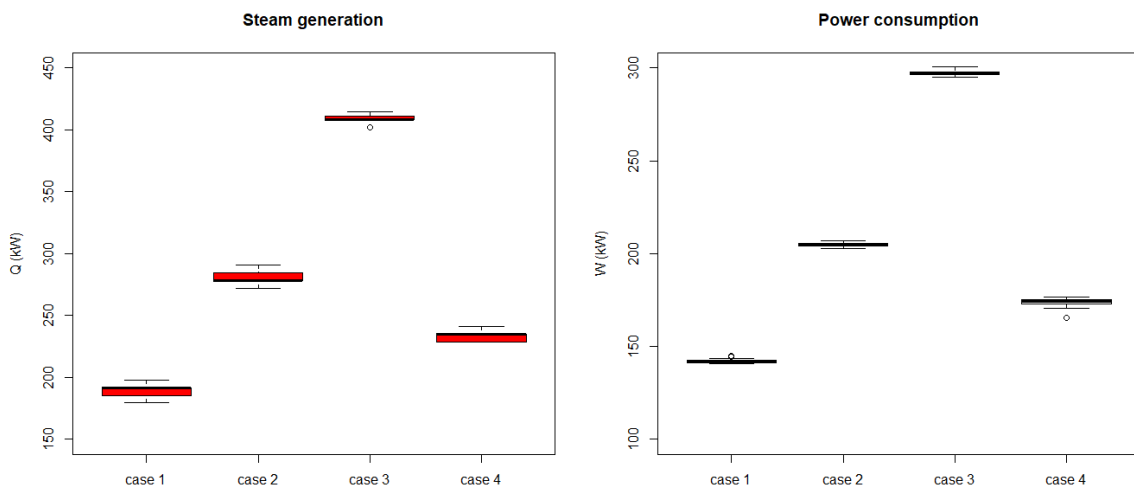

Figure 8. Steam generation and power consumption for the four cases. The steam generation is calculated from the flow of feed water, the feed water temperature and steam pressure. The power consumption is for the main motor and is sampled from the variable frequency drive.

As the conditions on the site are stable, the power consumption and the heat output are linear functions of the load. This can be seen in the figure above (Fig. 8), where the variations in the heat output (steam generation) and power consumptions for the four cases are presented.

The power consumption is only the consumption from the main motor that drives the heat pump measured from the variable frequency drive. In addition, two oil pumps add 1-2 kW of additional power that will not have major impact on the results. The system also has small circulation pumps running at partial load (0.75-2.2 kW full load) for the water circuits, which are not included in the analysis as they are not directly connected to the performance of the heat pump. Based on the power consumption and the steam generation, it is possible to estimate the coefficient of performance of the heat pumps as well as the system efficiency. This is presented in the figure (Fig. 9) below.

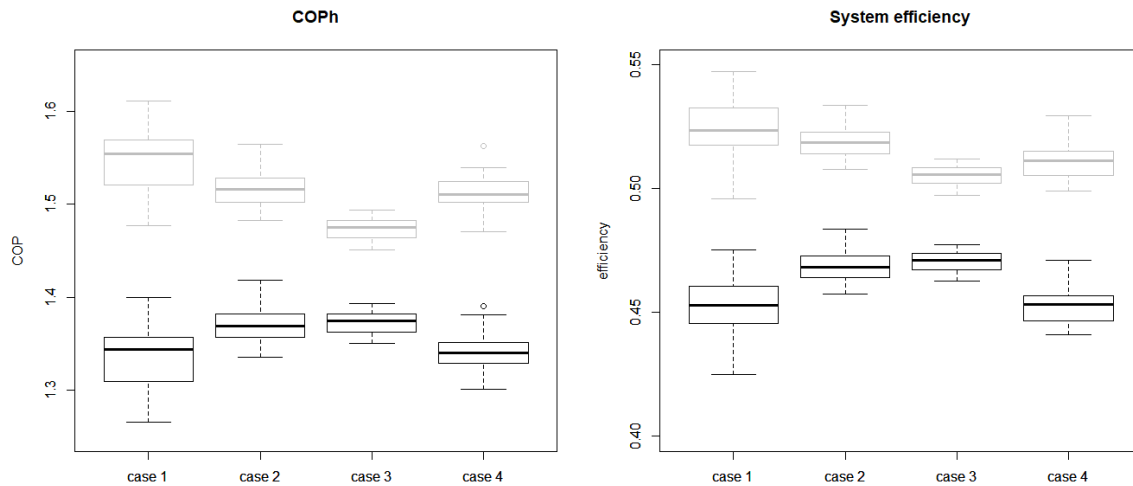

Figure 9. The coefficient of performance is defined as heat used to generated steam divided by the main motor consumption (i.e. $COP_h = Q_s/W$). The system efficiency is defined as the measured COP_h divided by the Carnot COP (i.e. $\eta_{system} = COP_h/COP_{carnot}$). The box and whisker plots in grey are estimated values for a fully thermally insulated heat pump.

During the operation of the heat pump, the heat loss has been higher than standard operation as large parts of the heat pump were not properly insulated. The heat loss has been estimated to approximately 30 kW, and the performance of a fully insulated heat pump is estimated and is shown in grey in the figures (Fig. 9) above.

6. Conclusions

A proven concept is described for a Stirling engine operated as an industrial-scale heat pump, delivering steam at 180°C. A brief assessment of losses and benefits is given, followed by technical performance data on the current installation at AstraZeneca's R&D centre in Sweden. Current activities involve improving system efficiency and reliability while increasing heat output from 500 to 750 kW, at the same time raising the TRL of the heat pump from level 7 to level 9.

Acknowledgements

The work described in this paper is partly financed by the European Commission under the Horizon 2020 Fast Track to Innovation programme, grant agreement number 831062 (2019-2021). Umara Khan at ÅAU is acknowledged for the Ansys Fluent CFD simulations, Mikhail Sinkevich of OT for background information.

References

- [1] Arpagaus C, Bless, F, Uhlmann M, Schiffmann J, Bertsch S. High temperature heat pumps: Market overview, state of the art, research status, refrigerants, and application potentials. *Energy* 152 (2018) 985-1010.
- [2] Bejan, A. *Advanced Engineering Thermodynamics* 2nd ed., John Wiley & Sons, 1997
- [3] Szargut, J., Morris, D., Steward, F.R. *Exergy Analysis of Thermal, Chemical and Metallurgical Processes*. Hemisphere Publishing Co, 1988.
- [4] Sowale, A., Kolios, A. Thermodynamic performance of heat exchangers in a free piston Stirling engine. *Energies* 11 (2018) 505 (open source)
- [5] Høeg, A, Tveit, T-M, Aase, T, Asphjell T-A. Mechanical Design of the 4-500 kWth Stirling Cycle Heat Pump SPP 4-106. 17th International Stirling Engine Conference, Newcastle upon Tyne, UK; 2016.
- [6] Tveit, T-M. Application of an industrial heat pump for steam generation using district heating as heat source. 12th IEA Heat Pump Conference HPC 2017; Rotterdam, Netherlands; 2017.
- [7] Tveit, T-M, Høeg A. Performance analysis and verification of a novel high temperature difference heat pump. 11th IEA Heat Pump Conference, Montréal, Canada; 2014.
- [8] Finkelstein, T., Organ, A.J. *Air Engines*, ASME Press, 2001
- [9] Moran, M.J., and Shapiro, H.N. *Fundamentals of Engineering Thermodynamics*, 2nd ed., John Wiley & Sons, 1993